

The Proceedings of the Seventeenth West Coast Conference on Formal Linguistics

edited by
Kimary Shahin, Susan Blake
& Eun-Sook Kim

Conference held at the
University of British Columbia
1998

Published for the
Stanford Linguistics Association
by the
Center for the Study of Language and Information

Derived Predicates and the Interpretation of Parasitic Gaps*

JON NISSENBAUM

Massachusetts Institute of Technology

1. Introduction

This paper provides empirical support for the claim that predication created by syntactic movement plays a role in syntactic computation. The proposal that every movement operation creates a predicate abstract over the target of movement was suggested by Heim and Kratzer (1998) in order to simplify the semantic component of the grammar. I show that it also has empirical consequences. Specifically, I demonstrate that well-known properties of Parasitic Gap (PG) constructions can be derived in a principled way from the proposal. Further, I present evidence for a previously unnoticed property of PGs inside subject NPs: they are licensed only if the subject undergoes reconstruction. I show that this property follows as well from the analysis.

The paradigm (1) illustrates three characteristic properties of PGs:

- PGs cannot be licensed by covert movement, as shown in (1b);
- they obey an anti-c-command condition (1c); and
- they are not licensed by A-movement to subject position (1d).

- (1) a. Which book did John look for _ in order to buy _ ?
b. *Who looked for which book in order to buy _ ?
c. *Which book did John buy _ for the man who wanted _ ?
d. *A book was pulled _ off the shelf in order (for me) to buy _

I will show that these properties can be explained on the basis of the Heim/Kratzer proposal, without recourse to stipulated conditions such as a requirement that PGs are licensed at s-structure, or by A-bar movement alone, or by ad hoc rules such as Chain Composition.

Building on the empty-operator analysis of Chomsky (1986), I propose that PG structures are licensed by exactly the same interpretive mechanism that licenses other null operator constructions. Specifically, I

* I am very grateful to Danny Fox and Martin Hackl for the countless hours they spent helping me develop the ideas in this paper. Special thanks are also due to Noam Chomsky, Michel DeGraff, Irene Heim and David Pesetsky for extremely helpful discussion and criticism, as well as to Rajesh Bhatt, Ken Hale, Sabine Iatridou, Orin Percus, Gina Rendon, Uli Sauerland, and the participants of the Spring 1997 generals workshop and the LF reading group at MIT.

argue that the constituent containing a PG (like other null operator constructions) is interpreted as a one-place predicate (type $\langle e, t \rangle$). If this predicate is to compose with the VP by a standard composition rule of predicate modification, then the latter must also be interpreted as a one-place predicate. I argue that an intermediate step of *wh*-movement in the main clause turns the VP into a derived predicate (by the Heim/Kratzer proposal), allowing composition with the adjoined constituent containing a PG. The resulting interpretation of the VP-plus-adjunct is that of a (conjoined) predicate, which can compose with the intermediate trace by standard Function Application. In this sense, the PG is in no way parasitic on *wh*-movement to Spec,CP, but rather is licensed solely by the intermediate trace.

The basic insight of the analysis is that the VP becomes a derived predicate by intermediate movement of the *wh*-phrase, and as such is able to compose by Predicate Modification with an adjunct in which a null operator binds a PG. Crucially, I will show that such an adjunct must merge *after* intermediate *wh*-movement to the VP (countercyclically). If merger of the adjunct *precedes* movement, then predicate modification will fail for type reasons: intermediate movement will form the predicate abstract over *both* the VP and the adjunct, too high to allow their composition.

The paper is organized as follows: section two gives the analysis in detail and demonstrates that the basic properties of PG constructions seen in (1) follow from it. A consequence will be that A-movement can in principle license PGs. Section three addresses subject PGs. A surprising prediction is shown: subjects with PGs will undergo obligatory reconstruction. The correctness of this prediction is supported by a variety of tests.

2. The analysis: movement and derived predication

2.1 Three assumptions about the syntax of Parasitic Gaps

The analysis rests on three non-innocent (but independently supported) assumptions about the syntax of PG constructions:

- PGs are bound by a null operator

Chomsky (1986) argued that PGs are bound not by the *wh*-phrase that binds the licensing gap (as in (2a)), but by a phonetically empty operator (2b).

- (2) a. [Which book]₁ did John [_{VP} look for *t*₁] [in order to buy *t*₁]
 b. [Which book]₁ did John [_{VP} look for *t*₁] [*Wh*₂ in order to buy *t*₂]

Other constructions that have been analyzed to have the across-the-board structure of (2a) differ from PG constructions in important respects. The claim that PGs are bound independently of the licensing gap predicts binding and reconstruction asymmetries (unlike ATB constructions), and there is ample evidence that such asymmetries exist.¹ For the purposes of this paper, we will simply take the null operator hypothesis as given.

¹ For a summary of Chomsky's arguments for the structure (2b), as well as further evidence, see Nissenbaum (1998). Cf. Munn (1992).

- Adjuncts which contain PGs are VP-adjuncts

The second assumption that is crucial for the analysis is that the relevant adjuncts are adjoined to VP, rather than internal to a right-branching VP. The kinds of adjuncts that typically host PGs are those headed by temporal prepositions (*before*, *after*, *while*), rationale clauses (*in order to...*, *because...*), and participial adjuncts headed by *without*. Arguments against a right-branching structure for such adjuncts are given in Nissenbaum (1998).

- *Wh*-movement leaves an intermediate trace at the VP

The third crucial assumption about the syntax of PG constructions is that the *wh*-movement that licenses a PG leaves an intermediate trace at the level of the VP, a position local to the attachment site of VP-adjuncts. Fox (forthcoming) gives compelling arguments that *wh*-movement passes through an intermediate position between the surface subject position and the highest internal argument of the VP. The copy of this intermediate movement is always unpronounced in English, but Fox shows that its presence at LF can be detected by means of a correlation between Condition C and variable binding reconstruction effects.

Taking these three independently motivated assumptions together, we may consider the structure (3) to reflect the basic syntactic properties of PG constructions and use it as the basis for an examination of the mechanisms involved in licensing PGs.

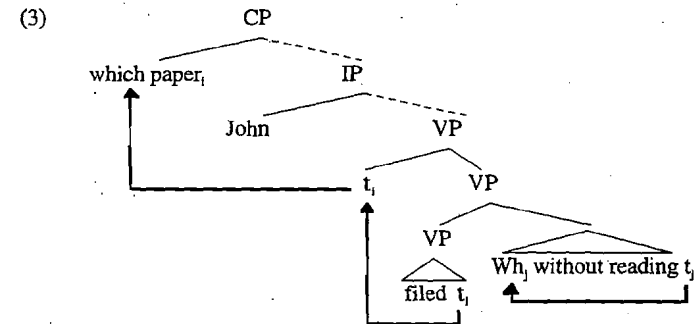

2.2 The interpretation of PG constructions

Given the structure (3), it is not obvious how the PG receives the right interpretation, or for that matter how the adjunct is supposed to compose with the main clause. Intuitively, we know that the PG is interpreted as "the same" as the licensing gap; "the paper that John filed without reading" refers to a single book which has the property that John filed it without reading it. The immediate goal is to account for this interpretation. The account will, in turn, explain the properties in (1) and make several important predictions.

The following fairly standard assumptions about semantic composition enter into the analysis.

§ VP adjuncts have the semantics of conjunction with VP

It is standard to assume that in addition to a basic composition rule of Function Application, the interpretive component of the grammar makes use of a rule that semantically conjoins two phrases. As already noted, a sentence like *John filed the paper without reading it* has a natural paraphrase as the conjunction *John filed the paper and he didn't read it*. Formally, we can spell this out by saying that the VP (with a VP-internal subject) and the adjunct are both propositional cores, with semantic type $\langle e, t \rangle$, their truth conditions are stated roughly in (4a) and (4b) respectively, with g taken as a variable assignment function and t_{subj} the subject trace. Their composition is then determined by the rule of semantic conjunction, yielding the denotation (4c). (Assume that PRO in the adjunct is a bound pronoun, anaphoric on the subject.)²

- (4) a. $\llbracket [_{VP} t_{subj} \text{ filed the paper}] \rrbracket^g = 1$ iff $g(t_{subj})$ filed the paper
- b. $\llbracket [\text{without PRO reading it}] \rrbracket^g = 1$ iff $\neg (g(\text{PRO}) \text{ read } g(it))$
- c. $\llbracket [_{VP} [_{VP} t_{subj} \text{ filed the paper}] [\text{without PRO reading it}]] \rrbracket^g$
 $= 1$ iff $g(t_{subj})$ filed the paper & $\neg (g(\text{PRO}) \text{ read } g(it))$

§ Null Operator Structures are predicates

Other constructions which have been argued to have null operators have the semantics of predicates: the operator binds a gap and turns the clause where it takes scope into a function of type $\langle e, t \rangle$. In relative clauses the wh-operator may be either null or overt, but in both cases the interpretation is the same: they are CPs that compose with NPs by predicate modification. Thus, "a cat that is grey" expresses the same meaning as "a grey cat":

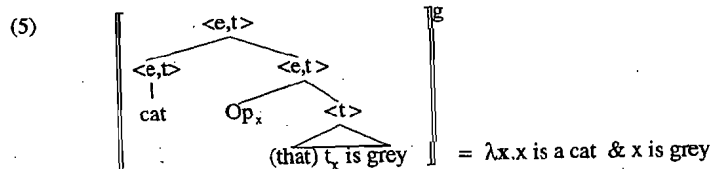

Given this general method of interpreting null operator structures, an adjunct like (4b) with a gap bound by an operator would be interpreted as in (6), roughly, "the set of objects that PRO didn't read":

(6) $\llbracket [Op_x [\text{without PRO reading } t_x]] \rrbracket^g = \lambda x. \neg (g(\text{PRO}) \text{ read } x)$

§ Every link in a chain is interpreted

Two-membered chains have a straightforward interpretation: the head binds the tail. What about three-membered chains like the one in (3)? It is sometimes assumed in the syntactic literature that intermediate traces delete

² The denotations in (4) are simplified for ease of presentation. For a more detailed analysis making use of Davidsonian event variables (as well as a treatment of more complicated adjuncts), see Nissenbaum (1998). There it is assumed that VPs and adjuncts are both predicates of events, and compose by predicate modification. The basic idea — that they semantically conjoin — is the same.

and that LF representations consequently contain only two-membered chains.³ However, it is a rather simple matter to extend the semantic rule that interprets chains (a rule of predicate abstraction) to structures with intermediate traces: each link higher than the tail binds the one immediately below it. The effect of such a rule is illustrated schematically below:

(7) $\llbracket [\text{Wh-phrase}[\dots t' \dots [\text{filed } t]]] \rrbracket = \text{Wh-phrase}[\lambda x. \dots t_x [\lambda y. \dots [\text{filed } t_y]]]$

The semantic rule of predicate abstraction that is required treats all instances of movement, including the intermediate step in (7), alike. Each step of movement is interpreted as the sister of a lambda abstract, hence as the binder of its trace. The interpretation of multi-link chains is identical to that of simple chains where the intermediate traces have deleted, so there is no obvious reason to assume that intermediate traces must delete. If (3) correctly reflects the structure of PG sentences, then the presence of the intermediate trace in the LF is crucial, as is shown in the next subsection.

2.3 How VPs compose with Null Operator structures

Recall that ordinary VP adjuncts (with no PG) compose with VPs by an interpretive rule that semantically conjoins two proposition-denoting sisters (type $\langle e, t \rangle$). But an adjunct with a PG is *not* a proposition — the null operator that binds the gap turns it into a predicate of type $\langle e, t \rangle$, as noted above. If a VP is a proposition, and an adjunct with a PG (i.e. a null operator structure) is a predicate, there is no straightforward semantic rule by which they could compose.

However, given the rule of predicate abstraction which is needed independently for interpreting chains, then the VP is *also* interpreted as a predicate — provided, crucially, that the intermediate trace is present at LF. That is, the presence of the intermediate trace *forces* the VP to be interpreted as a lambda abstract. So as long as there is an intermediate trace for them to compose with, the VP and the adjunct can semantically conjoin by the same rule of predicate modification that conjoins relative clauses and NPs. The resulting conjoined predicate composes with the intermediate trace by standard function application, yielding a VP of type $\langle e, t \rangle$.

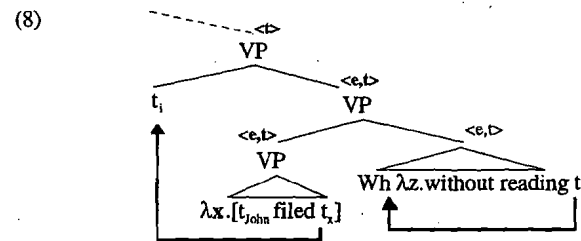

One important loose end remains to be tied up. The rule of predicate abstraction needs to be formulated so as to guarantee that *only* the *lowest* VP segment becomes a lambda abstract. Otherwise (if both lower segments were to be interpreted as a single lambda abstract), then the lowest

³ For instance, by Lasnik and Saito (1984).

VP would still not be of the right semantic type to compose with the adjunct. This outcome is illustrated in (8'):

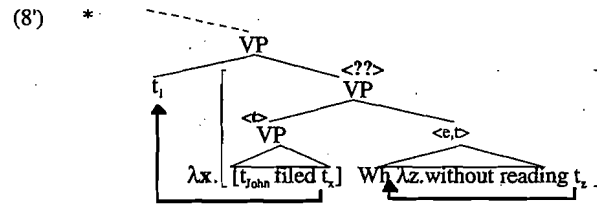

How can we guarantee that the rule of predicate abstraction yields (8) instead of (8')? Clearly the simplest way of formulating the predicate abstraction rule would be to say that the *sister* of the moved constituent becomes a predicate abstract. But such a formulation would yield the unwanted (8').

It turns out, however, that the simplest formulation will work, if we adopt exactly the version that was proposed by Heim and Kratzer (1998).

2.4 Movement creates derived predicates in the syntax

Heim and Kratzer proposed that the work done by the predicate abstraction rule is divided into a syntactic and a semantic component. Specifically, they proposed that every syntactic movement operation introduces a predicate abstract to the target of movement *during the course of the syntactic computation*. The output of a syntactic movement thus looks like the structure (9a) rather than the more standard (9b).

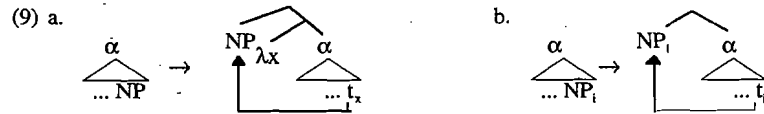

This proposal allowed Heim and Kratzer to greatly simplify the semantic component: the binding relation that holds between the two links in the chain is read directly off the LF.

2.5 Countercyclic adjunction

Note that the Heim-Kratzer proposal appears to guarantee exactly the wrong result, namely it would yield the structure (8') rather than (8). However, this appearance is misleading. The assumption that movement creates predicate abstracts allows a derivational solution to the problem, since a predicate that is created derivationally might in principle be eligible for subsequent syntactic operations. The type mismatch in (8') need not arise, if the adjunct merges at a point in the derivation where the predicate abstract over the VP has already been formed.⁴ Consider the structure at three successive stages of the derivation:

⁴ This assumes that some operations do not need to obey the cycle. Lebeaux proposed that countercyclic merger of relative clauses is possible, to explain the absence of Condition C effects within a copy theory of movement. See also Sauerland (1998) for another empirical argument in favor of the Heim/Kratzer proposal.

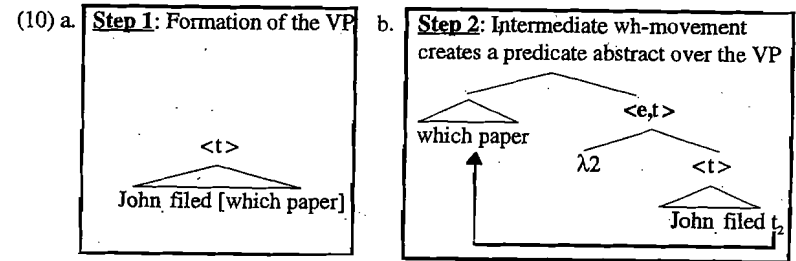

The first two steps, shown in (10a-b), are the construction of the VP (without the adjunct), and then wh-movement of the wh-phrase to the intermediate VP-level position (using rule (9a)). Prior to the movement, the VP is a proposition (type <t>). The intermediate wh-movement creates a predicate abstract over the VP, turning it into a predicate (type <e,t>).

Recall that the interpretability problem of (8') stemmed from the fact that the adjunct, a predicate, needed to compose with another predicate. But *after* the intermediate wh-movement of Step 2, there is a suitable node to which the adjunct clause can adjoin (and ultimately compose by Predicate Modification) — the predicate abstract formed by the movement itself. The third step, illustrated in (10c), is the merger of the adjunct with the newly derived predicate. Crucially, merger is to a position *immediately below* the root, to the sister node of the moved wh-phrase, a node that did not exist until it was created by the movement.

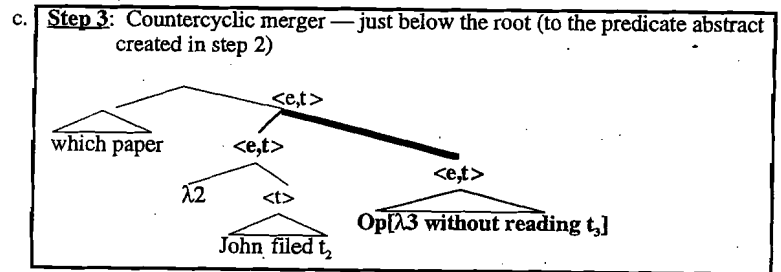

The wh-phrase ultimately raises to Spec,CP of the matrix clause, leaving a trace at the VP-level. Interpretation of the resulting structure is now straightforward. The VP and the adjunct, both being predicates, compose at LF by Predicate Modification. This conjoined predicate, whose denotation is stated in (11a), is the right semantic type to compose with the trace (a variable of type <e>) by Function Application. The result of that composition in turn denotes a proposition (11b).

- (11) a. $\llbracket \llbracket [_{VP} [_{VP} \lambda 2 \text{John filed } t_2] [Op \lambda 3 \text{ without PRO reading } t_2]] \rrbracket \rrbracket \mathbb{E}$
 $= \lambda y. \text{John filed } y \ \& \ \neg(\text{g(PRO) read } y)$
- b. $\llbracket \llbracket [_{VP} t \llbracket [_{VP} [_{VP} \lambda 2 \text{John filed } t_2] [Op \lambda 3 \text{ without PRO reading } t_2]] \rrbracket \rrbracket \rrbracket \mathbb{E}$
 $= 1 \text{ iff John filed } g(t) \ \& \ \neg(\text{g(PRO) read } g(t)).$

To summarize, in order to guarantee an LF like (8) rather than (8'), two components are needed: (i) the intermediate wh-trace is the sister of a predicate abstract, and (ii) merger of the adjunct may be countercyclic — it may merge to the predicate abstract over the VP after the latter is formed. An adjunct with a PG crucially *must* merge counter-cyclically (step 3). If merger in (10) had been cyclic (i.e., before the intermediate wh-movement), then the wh-movement would have formed its predicate abstract over *both* the VP and the adjunct — too high to allow their composition.

2.6 Results of the analysis

•Covert movements don't license PGs

It follows automatically that movements after spellout will not license adjuncts containing PGs, since such adjuncts must crucially merge to a predicate abstract that does not exist before movement. If the adjunct were to merge before the licensing movement, then the predicate abstract would be *formed over a constituent containing both VP and adjunct*, too high to allow their composition. On the other hand, an adjunct that merges after a covert movement (post-spellout) could not be pronounced, assuming a Y-model of the grammar.

•Anti-c-command condition

The analysis also derives the anti-c-command condition as an automatic consequence. Since the null operator phrase must merge to a predicate derived by movement, it follows both that the trace of the licensing movement cannot c-command the PG, and that the null-operator-containing phrase itself will end up c-commanding the trace of the original movement.

•Subject A-movements don't license PGs

It is also a trivial result of this theory that A-movement under passivization, or A-movement of a VP-internal subject, will not license a PG, under the well-motivated assumption that there is no intermediate A-movement step that would put such a phrase in a position to license an adjunct with a PG. If A-movement to a VP-position is case-driven, it is an accusative case position. If, on the other hand, subjects *adjoined* to VP as a first step, further movement (to IP) would constitute improper movement.

•A Further Prediction: short A-movement (of objects) *does* license PGs

The analysis predicts that cases of overt A-movement to the VP level should license PGs. This prediction is amply borne out by short scrambling in German, Dutch and Hindi. As noted by Weibelhuth (1989), Mahajan (1990) and Deprez (1989), short scrambling in these languages displays all the hallmark properties of A-movement, yet it also licenses PGs. This fact has been considered paradoxical in the literature. But under the account proposed here the "paradox" evaporates, because the stipulation that PGs are solely an A-bar-movement property has been dispensed with. The puzzle is resolved unequivocally: short scrambling in these languages is A-movement. It is local to VP, so it licenses PGs as predicted.

3. Parasitic Gaps inside subjects

So far, we have only addressed PGs contained in VP adjuncts. But as is well known, PGs are licensed in subjects as well ((12a) is from Kayne 1983):

- (12) a. John's a guy that [people who talk to _] usually end up liking _
 b. Johns' the guy that we invited because [everyone who talks to _] is likely to appreciate _

Under the analysis proposed in the previous section, the licensing of subject PGs would follow in essentially the same way as the licensing of adjuncts with PGs — *if* such subjects were interpreted in their base position at LF.

3.1 Licensing of subject NPs in the VP-internal position

The crucial step in the analysis is the "sandwiching" of the PG adjunct in between the intermediate trace and the predicate abstract created by its movement. In principle, *any* VP-level constituent containing a PG could be licensed in the same manner, assuming that its semantic type is suitable for composition with the abstract over the VP (type $\langle e, t \rangle$). In other words, this same intermediate trace could in principle license VP-internal PG subjects as well as adjuncts, provided that (i) the subject could merge countercyclically to the derived predicate formed by the intermediate movement, and (ii) the subject's semantic type allows it to compose with the derived predicate.

Assume, then, that subjects containing PGs are allowed to merge countercyclically. As noted, the analysis forces this consequence. The constituent with the PG needs to be the *sister* of the predicate abstract of the licensing movement, and if it were to merge cyclically, then the predicate abstract would be too high (over the node *dominating* the PG constituent).⁵

The next thing to establish about PG subjects is their semantic type. We might begin with a consideration of bare plural subject NPs, since subject PGs quite often involve bare plurals. Assume that bare plural NPs are predicates of type $\langle e, t \rangle$, suitable for composing with V' by Predicate Modification. Thus, the NP in (13a) composes with V' (13b) to form (13c), both of whose open positions may be bound by existential closure.

- (13) a. $[[\text{people who talk to John}]]_{\mathcal{E}} = \lambda x. \text{people}(x) \ \& \ x \ \text{talk to John}$
 b. $[[\text{like him}]]_{\mathcal{E}} = \lambda x. x \ \text{like } g(\text{him})$
 c. $[[\text{people who talk to John}][\text{like him}]]_{\mathcal{E}}$
 $= \lambda x. \text{people}(x) \ \& \ x \ \text{talk to John} \ \& \ x \ \text{like } g(\text{him})$

If bare plurals could compose with V' by PM in the ordinary case, as above, then a bare plural with a PG would be a *two*-place predicate of type $\langle e, \langle e, t \rangle \rangle$ in virtue of the operator binding the PG, as in (14). Hence composition with V' should be impossible.

⁵ The countercyclic operation is not unprecedented. In addition to Lebeaux's proposal for NP adjuncts (see footnote 4), Richards (1997) proposes de-coupling the cycle from the Extension Condition: the first instance of wh-movement must extend the tree, but subsequent movements tuck the mover into a position just below the previously moved phrase. We might similarly redefine the cycle so as to permit merger of a phrase to the node immediately below the root just in case the preceding operation resulted in a recomputation of the semantic (or, possibly, phonetic) properties of this node.

- (14) $\llbracket OP_y [people\ who\ talk\ to\ t_y] \rrbracket g = \lambda y. \lambda x. people(x) \ \& \ x\ talk\ to\ y$

As noted above, however, there is a way for the grammar to allow the constituent in (14) compose with V': the same way as for adjuncts. After an intermediate licensing movement forms a predicate abstract (in this case over V'), the subject merges countercyclically to the predicate abstract:

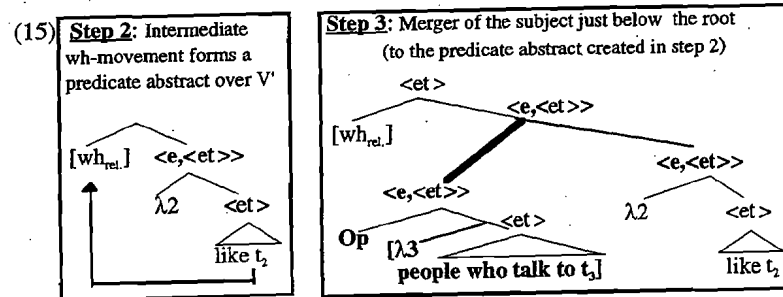

Just as before, the node immediately below the root in (15a) is exactly the right semantic type to allow composition with the subject NP by the rule PM (15b). The resulting denotation, also a two-place predicate, composes with the intermediate trace by Function Application. The remaining open position is then bound externally (by an existential or generic operator).

Thus, the theory allows bare plural subject NPs with PGs to be interpreted in their base position, on the assumption that bare plurals have the same semantic type as V' and that countercyclic merger is allowed.⁶

3.2 Licensing is only possible in the base position

But *are* PG subjects interpreted in their base position at LF? It turns out that they must be. This is an unavoidable consequence of the theory, because it arises from the claim that the constituent with a PG must "sandwich" between some previously moved element and its derived predicate. (Its sister must be the lambda abstract of a licensing movement.) But given the crucial assumption that movement creates derived predicates, a subject containing a PG would, by raising, create its own predicate abstract over the one already formed by the licensing wh-movement — so its sister can *in principle* never be the lambda abstract of the licensing movement. A raised subject (or for that matter any raised constituent) containing a PG would therefore never be able to compose with its sister.⁷

Thus, the theory predicts that a subject NP can contain a PG *only if it is interpreted in its base position*. The rest of this section will show that, indeed, subjects with PGs yield reconstruction effects in every instance.

⁶ An added complication is introduced when we consider PGs inside quantifier phrases. Generalized quantifiers do not compose with their sisters by Predicate Modification, but rather by Function Application. This problem turns out to be fairly easy to resolve, if we allow a natural extension and redefinition of Heim and Kratzer's basic composition rules as a single recursive operation, as proposed in Nissenbaum (1998).

⁷ For a demonstration that this is the case, see Nissenbaum (1998), section 4.1.3. What is actually shown there is that even under stipulated conditions that would allow Predicate Modification, the resulting LF would always yield a Strong Crossover violation.

3.3 The prediction confirmed: subject PGs must reconstruct

(a) Variable binding from the raised position

If subject QPs need to reconstruct in order to license a PG, then we would expect a variable that can only be bound from the raised position to create a conflict with a PG in the subject. This expectation is borne out in (16). (16a) is an acceptable instance of a PG contained in a QP that has undergone surface A-movement over the raising predicate *appear*. (16b) is the test case: the PG becomes unacceptable when the QP subject containing it needs to bind a variable from the raised position. (16c) is a further control, showing that the QP is able to bind a variable from its raised position if it doesn't contain a PG. (Example (16d) shows that binding by a PG subject is no problem if the variable can be bound from the reconstructed position)

- (16) a. Sue's the kind of person that [everyone who talks to $_$] appears to my colleagues to like $_$.
- b. *Sue's the kind of person that [everyone who talks to $_$]_i appears to his_i colleagues to like $_$.
- c. Sue's the kind of person that [everyone I know]_i appears to his_i colleagues to like $_$.
- d. cf. Sue's the kind of person that [everyone who talks to $_$]_i appears to want his_i colleagues to meet $_$.

(b) Condition C violations resulting from reconstruction

Obligatory reconstruction should also create Condition C effects.⁸ (17)-(18) bear out this prediction. The (a) examples are the control cases, with the r-expression and the co-indexed pronoun positioned such that reconstruction would not violate condition C. The test cases are the (b) sentences, and as predicted they are very much degraded in acceptability. The (c) sentences are identical to those in (b) except that the pronoun is embedded so as not to c-command the reconstructed r-expression, providing a further control to show that Condition C is the relevant factor.

- (17) a. Mary's the one that [his_i constant criticism of $_$] seemed to John_i to have (finally) upset $_$.
- b. *Mary's the one that [John's_i constant criticism of $_$] seemed to him_i to have (finally) upset $_$.
- c. Mary's the one that [John's_i constant criticism of $_$] seemed to [his_i mother] to have upset $_$.
- (18) a. That's the kind of film that [people who recommend $_$ to her_i] usually strike Mary_i as liking $_$ for the wrong reasons
- b. *That's the kind of film that [people who recommend $_$ to Mary_i] usually strike her_i as liking $_$ for the wrong reasons
- c. That's the kind of film that [people who recommend $_$ to Mary_i] usually strike [her_i husband] as liking $_$ for the wrong reasons

⁸ On the assumption that binding conditions are sensitive to scope reconstruction, as expected under Chomsky (1993), and argued for empirically by Fox (forthcoming) and Romero (1997).

(c) Scope interactions with modals

The first two tests were grammaticality judgment paradigms. The examples in (19)-(20) make use of ambiguities created by QP subjects and modal verbs. Ordinarily such sentences are ambiguous between a meaning where the surface scope relation is preserved, and an inverse scope interpretation resulting from optional subject reconstruction. (19a) illustrates the ambiguity by means of two disambiguating follow-up clauses. (19a) may be felicitously followed up by (i) in a context where *anyone* from the department would be sufficient to achieve the desired result, whereas professors from other departments would not sufficiently draw attendance if they taught the topic. This is the interpretation that results from subject reconstruction below *needs*; the interpretation can be paraphrased as "It needs to be the case that someone from our department teaches the topic..."

- (19) a. This is the topic that someone in our department needs to teach...
 (i) ... if we want people to show up (subject takes narrow scope)
 (ii) ... if the guy ever wants tenure (subject takes wide scope)

If, on the other hand, (19a) is followed up by (ii), the sentence is disambiguated toward a wide scope reading for the subject. With this meaning, the sentence cannot be paraphrased as above, but only as "There's someone in our department such that he needs to teach this topic..."

A parasitic gap in the subject disambiguates such sentences, allowing only the narrow scope reading.⁹

- (19) b. This is the topic that someone who's (just) written about _ needs to teach _ (if we want people to show up).
 c. *This is the topic that someone who's (just) written about _ needs to teach _ (if the guy ever wants tenure).

The same logic is used in (20). (20a) has two versions. Disambiguating follow-up sentences are provided, and in addition each of the two interpretations for the sentence comes with a characteristic intonation pattern, very crudely reflected by upper- and lower-case letters. The narrow scope (i) states that "it must happen that no one leaves," and the wide scope (ii) merely asserts that there is no particular individual who must leave.

- (20) a. (i) No one must LEAVE. (If anyone does, there will be a severe penalty) (narrow scope)
 (ii) NO one MUST leave. (But everyone should feel free to) (wide scope)

It is important to note that the narrow scope reading of (20a) is the more marked reading. It is therefore all the more surprising that this is the only

⁹ The contrast in (19) is not due to the so-called "specific" interpretation of the indefinite in (19c). If we further embed the indefinite under the scope of a universal quantifier, as in (i)-(ii), the indefinite in (ii) can lose its specific character yet the contrast remains:

- (i) This is the topic that every dean thinks someone who's (just) written about _ needs to teach _ (if we want people to show up).
 (ii) *This is the topic that every dean thinks someone who's (just) written about _ needs to teach _ (if the guy ever wants tenure)

reading that is available when a PG is put in the subject, as shown by the contrast between (b) and (c). This is so no matter what intonation pattern is used. Once again, the facts provide striking support for the prediction that subject PGs are licensed only under reconstruction.

- (20) b. John's the guy who no one that insulted _ must talk to _ (or he'll be really upset) (narrow)
 c. #John's the guy who NO one that insulted _ MUST talk to _ (but everyone should feel free to) (wide)

(d) Interactions with other scope-bearing predicates

The same test as above can be replicated with other kinds of predicates besides modal auxiliaries. The indefinite subject of (21) can take either narrow or wide scope with respect to *likely*. The narrow scope version (21a) is felicitous in a context where *you* refers to an individual who is an inside candidate for the job (and thus has a good chance at getting it). The wide scope (21b) is only felicitous in a context where *you* is not an inside candidate (and thus has a poor chance). Here, as in (24), the two meanings have characteristic pronunciations (indicated crudely by capital letters).

- (21) a. That's the job that you've got a decent shot at _ because an inside candidate is LIKELY to get _ (Presumption: "you" are an inside candidate)
 b. That's the job that you shouldn't even bother with _ because an INSIDE CANDidate is likely to get _ ("You" are not an inside candidate)

Again, using the condition set up in (21), we can test the reconstruction hypothesis by putting a parasitic gap inside the QP. And as the hypothesis predicts, the sentence is disambiguated in favor of narrow scope reading:

- (22) a. That's the job that you've got a decent shot at _ because an inside candidate for _ is LIKELY to get _
 b. *That's the job that you shouldn't even bother with _ because an INSIDE CANDidate for _ is likely to get _

3.4 A note on PGs in bare plural subjects

It is sometimes claimed, contrary to what is argued here, that bare plural subjects do not reconstruct in generic environments. Diesing (1992) and Kratzer (1989) proposed a correlation between interpretation of bare plurals and their structural position at LF: reconstructed bare plurals are interpreted existentially, while VP-external bare plurals are interpreted generically (by Diesing's Mapping Hypothesis). Obviously, this hypothesis is incompatible with the claim that subject NPs containing PGs must reconstruct, given the fact that subject PGs are often found in generic bare plurals.

The Diesing/Kratzer account is apparently given strong support by examples such as (23)-(24). A-movement of (existentially interpreted) bare plurals (23) doesn't allow variable binding (A-movement generally allows binding from the raised position in these environments (23d)). When the bare plurals are interpreted generically rather than existentially as in (24), however, variable binding from the raised position is perfectly acceptable.

- (23)a. *Chimps seem to their caretakers to be in the room
 b. *Chimps strike their caretakers as being in the room
 c. *Chimps are expected by their caretakers to be in the room
 d. cf. *Several chimps seem to their caretakers to be in the room*
- (24)a. Chimps always seem to their caretakers to be in the room/smart
 b. Chimps often strike their caretakers as being in the room/smart
 c. Chimps are usually expected by their caretakers to be in the room

However, (25) casts doubt on the Diesing/Kratzer account. While the unacceptability of the examples in (25a) are fully expected (since the variables are not in the scope of their binders) the acceptability of the (25b) examples comes as a complete surprise.

- (25)a. *It seems to their caretakers that chimps are in the room
 *It strikes their caretakers that chimps are intelligent
- b. It always seems to their caretakers that chimps are in the room
 It often strikes their caretakers that chimps are intelligent

No current theory (to my knowledge) predicts a covert movement of the bare plural in (25b) to license the pronoun. Diesing and Kratzer do not predict that this should even be necessary: the embedded clauses allow a generic operator to license the bare plurals in their surface position, so covert raising is not forced. If covert raising is simply allowed (to bind the pronoun), then the unacceptability of (25a) is unexplained.

Whatever is going on in (25b) to make them acceptable, it is clear that they are not grossly different in interpretation from the examples in (24). Therefore, to the extent that an alternative analysis is warranted for (25b) which licenses the pronouns in some manner other than binding by the NP, it is reasonable to suppose that such an analysis also allows the pronouns in (24) to get an interpretation other than as bound by the NP. It is then far from obvious that (24) supports the Diesing/Kratzer claim that bare plurals don't reconstruct in generic sentences. And we have already seen evidence (e.g. 18) that bare plurals do reconstruct, if they contain PGs.

4. Conclusions

This paper showed empirical consequences of Heim and Kratzer's proposal that the semantic reflex of constituent movement is encoded directly in the syntactic derivation. The evidence in support of their proposal was provided by an analysis of parasitic gap constructions. The analysis accounts in a non-stipulative way for three of the characteristic properties of the construction: the requirement for licensing by an overt movement, the failure of subject A-movement to license PGs, and the anti-c-command condition. A prediction was made that A-movement can, in principle, license PGs, and it was suggested that short scrambling represents such a case. Furthermore, a previously unnoticed property of PGs was shown to follow from the analysis, namely that PGs in subjects can be licensed only if the subject undergoes reconstruction at LF. An array of evidence was presented to show that this prediction is correct. Most available alternative

accounts of PG licensing require stipulations that the construction is licensed at s-structure and that the licensing movement is limited to A-bar movement. No available alternative theory predicts the subject reconstruction property; the HPSG/connectedness family of theories (Kayne 1983, Sag 1983), and Steedman (1997), as well as Richards (1997) all predict that subject NPs should be able to host PGs as long as the subject c-commands the licensing gap.

The major consequence of the analysis, in addition to the support it provides to the Heim/Kratzer proposal, is that it argues in favor of the Y-model of the grammar; the explanation for lack of PG licensing by covert movements rests on the assumption that operations after spellout cannot be reflected in the phonetic form. Finally, the discovery of reconstruction effects for PG subjects has fairly broad implications for the theory of reconstruction and the analysis of bare plurals.

References

- Chomsky, Noam (1986), *Barriers*, MIT Press.
- Chomsky, Noam (1993), "A Minimalist Program for Linguistic Theory," in K. Hale & S. J. Keyser, eds., *The View From Building 20: Essays in Honor of Sylvain Bromberger*, MIT Press.
- Deprez, Vivienne (1989), *On the Typology of Syntactic Positions and the Nature of Chains*. PhD Dissertation, MIT. Distributed by MITWPL.
- Diesing, Molly (1992), *Indefinites*, MIT Press.
- Engdahl, Elizabeth (1983), "Parasitic Gaps," in *Linguistics and Philosophy* 6, 5-34.
- Fox, Danny (1995), "Economy and Scope," in *Natural Language Semantics* 3.3, 283-341.
- Fox, Danny (forthcoming), "Reconstruction, Binding Theory, and the Interpretation of Chains," to appear in *Linguistic Inquiry*.
- Heim, Irene, and Angelika Kratzer (1998), *Semantics and Generative Grammar*, Blackwell.
- Kayne, Richard (1983), "Connectedness," in *Linguistic Inquiry* 14.2, 223-220.
- Kratzer, Angelika (1988), "Stage-Level and Individual-Level Predicates," in G. Carlson and F. J. Pelletier, *The Generic Book*, Univ. of Chicago Press (1995).
- Lasnik, Howard, and Mamoro Saito (1984), *Move α* , MIT Press.
- Lebeaux, David (1988), *Language Acquisition and the Form of the Grammar*, PhD dissertation, UMass. Distributed by GLSA.
- Mahajan, Anoop (1989), *The A/A-bar Distinction and Movement Theory*. PhD dissertation, MIT. Distributed by MITWPL.
- Munn, Alan (1992), "A Null Operator Analysis of ATB Gaps," in *The Linguistic Review* 9.1, 1-26.
- Nissenbaum, Jon (1998), "Movement and Derived Predicates: Evidence from Parasitic Gaps," in *The Interpretive Tract*, MITWPL 25, 247-295.
- Pesetsky, David (1995), *Zero Syntax*, MIT Press.
- Richards, Norvin (1997), *What moves where when in which language?* PhD dissertation, MIT. Distributed by MITWPL.
- Romero, Maribel (1998), "The Correlation between Scope Reconstruction and Connectivity Effects," in *The Proceedings of the 16th West Coast Conference on Formal Linguistics*, CSLI.
- Sag, Ivan (1983), "On Parasitic Gaps," in *Linguistics and Philosophy* 6, 35-45.
- Sauerland, Uli (1998), "Plurals, Derived Predicates and Reciprocals," in *The Interpretive Tract*, MITWPL 25, 177-204.
- Steedman, Mark (1997), *Surface Structure and Interpretation*, MIT Press.
- Webelhuth, Gert (1989), *Syntactic Saturation Phenomena and the Modern Germanic Languages*. PhD dissertation, University of Massachusetts, Amherst. Distributed by GLSA.